

### Features



- 4 independent delay channels (or 8 in option)  
100 ps delay resolution (or 1 ps in option)  
50 ps channel to channel RMS jitter (4 ps in option)
- Output pulse 1.5 to 5 V into 50 Ω, 1 ns rise and fall time with independent control of width, polarity, amplitude, burst and MUX mode
- Up to 50 MHz independent trigger rate (repetitive or single) for every channel
- External trigger mode with pre-scaler or internal trigger mode from three synchronous programmable timers or command
- Gate (or second trigger) input
- External clocking up to 240 MHz (user programmable)
- Controlled via USB and Ethernet (or Bluetooth in option)
- Ultra-compact packaging and low power
- External AC/DC compact power supply
- OEM version (board level) 2 or 4 delay channels
- Channel output amplitude options: 3 V to 10 V or 15 V to 50 V or LVDS level

### Applications

- System Laser Timing Control
- ATE Application
- Laser Pulse Piking
- Precision Pulse Application
- Instrument Triggering
- Components Test

### Description

The GFT1604 Mini Pulse & Delay Generator provides 4 (or 8 in option) independent delayed pulses. Delays up to 100 seconds can be programmed with 100 ps resolution and channel to channel jitter less than 50 ps RMS. Options allow to enhance delay resolution to 1 ps and provide up to 500 ps precise pulse with 4 ps RMS jitter.

SMB outputs deliver 1.5 V to 5 V, 1 ns rise time pulses, into 50 Ω. Pulse amplitude, polarity, width and burst count are adjustable on each output channel. In option, pulse amplitude can be 3 V to 10 V or 15 V to 50 V into 50 Ω or LVDS level.

The model GFT1604 offer two inputs or three internal synchronized Timers (adjustable from 0.01 Hz to 50 MHz) or software command for triggering all selected delay channel. Either trigger rate may be set as one-shot or repetitive. Gate Input allows to quickly inhibit all selected channel Outputs: this input function can be selected as a second external Trigger or as an input/output for daisy chaining two GFT1604 to increase channel number.

The generator uses an internal 100 MHz TCXO clock reference, or an external user programmable (from 10 MHz to 240 MHz) clock (sine or square).

On front panel many LED indicators are included to indicate when input or output are running, and a RUN/STOP button enables/disables the output for all channels.

GFT1604 parameters can be remote controlled via USB to UART or Ethernet (or Bluetooth in option).

A multi-channel "Real Time Chart View" allows the user to visualize every channel output in a precise common time chart on your PC. Zoom and cursor functions allow precise time measurement and control.

**Application example:** The GFT1604 is well suited to synchronize all the devices of a Picosecond Laser System with only one compact unit and one GUI. In this application the "Clock reference input" of the delay generator receives a reference signal (80 MHz for example) from laser oscillator via an O/E (optical to electrical converter)

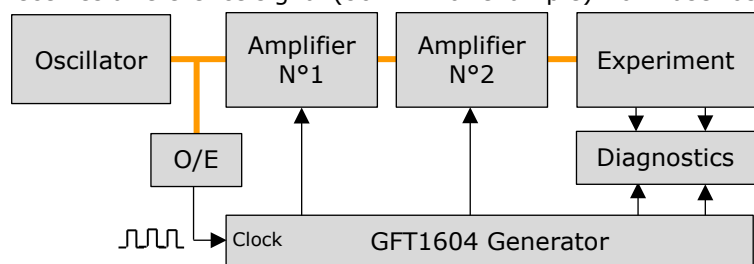

*Picosecond laser System*

From the GFT1604 Generator each amplifier (Pump-laser, Q-switch, Pockel cell ...) or diagnostic instruments (Digitizer, Calorimeter, CCD camera ...) can receive repetitive or single pulses (adjusted in rate, delay, amplitude, polarity and width) synchronized on "Clock reference input" with a very low jitter.

From generator 4 GPIO (input or output) under software control allow command for security or control to low frequency devices.



# GFT1604

## Mini Pulse & Delay Generator

### Specifications

<b>Delay channels</b>	
Number	4 independents (or 8 in option)
Range	100 seconds
Resolution	100 ps (1 ps in option)
RMS jitter	<50 ps + delay x 10 <sup>-7</sup> , channel to channel (up to 4 ps with options 2 + 5) <1 ns, external trigger to any channel (<100ps with option 10) <50 ps, external clock to any channel (10 ps with option 2)
Accuracy	<250 ps + delay x 10 <sup>-6</sup> (<100 ps + delay x 10 <sup>-6</sup> with option 2)
Time base	Internal 200 MHz, ±1 ppm stability
<b>External Trigger Mode</b>	
Input "TRIG"	Rate single or repetitive up to 40 MHz, with prescaler, adjustable threshold from +100 mV to +5 V (step 1 mV), adjustable positive or negative slope and 5 ns min pulse width
Trigger delay	<85 ns (insertion delay) (<105 ns with option 10)
<b>Internal Trigger Mode</b>	
Rate repetitive	From three Timers with frequency = 0.01 Hz to 50 MHz (in step of 5 ns)
Rate single	Synchronized on internals timers or soft command
<b>Channel Output pulse T1 to T4 (and T5 to T8)</b>	
Amplitude	1.5 V to 5 V in step of 1 mV into 50 Ω 3.0 V to 10 V in step of 2 mV into high impedance (>1 kΩ)
Rise/Fall Time	1 ns / 1 ns into 50 Ω or 2 ns / 2 ns into high impedance @ full scale
Width	10 ns to 10 s in step of 5 ns
Pulse Polarity	Positive or Negative
Burst Mode	Burst count = 1 to 1 000 000 000, adjustable period in step of 5 ns
MUX Mode	Any channel may be ORed' to all outputs (per group of 4)
<b>External Clock reference</b>	
Threshold	0 V, internal 50 Ω
Level	Min -10 dBm, typical 6 dBm
Frequency	10 MHz to 240 MHz, user programmable in steps of 0.25 MHz up to 120 MHz then user programmable in steps of 0.50 MHz
<b>Clock output</b>	
Level	>500 mV p-p, into 50 Ω, AC coupling
Frequency	100 MHz if internal clocked or same as external if external clocked (100 MHz with option 2)
<b>Gate or second trigger or daisy chaining</b>	
Function	Gate or second External Trigger with adjustable threshold or daisy chaining to second GFT1604
Input	Active high or low in gate mode, positive/negative slope with rate <40 MHz in trigger mode
<b>GPIO: Input or output lines</b>	
4 x GPIO	Input or output, 0 or 3 V level, impedance > 20 kΩ input & 100 Ω output
<b>General</b>	
Interface Control	USB to UART, Ethernet 10/100 Mb/s, Bluetooth in option
User's sets	8 sets to save or recall eight specific configurations
Software tools	Free Drivers for Windows 10/11 and Linux, USB application with GUI is furnished
Power consumption	2.5 W to 15 W according to configuration
Power supply	USB or External AC (80 - 264 V/47 - 63 Hz) to DC (5 V, 4 A), adapter furnished
Size and Weight	108 x 58.6 x 129 mm, < 1kg
<b>Options</b>	
Option 1:	Extension to 8 channels
Option 2:	1 ps delay resolution (only available with GFT1604-4C model), with channel-to-channel jitter <10 ps (at short delay) and min width of 50 ns <u>Narrow pulse mode</u> : it allows min width of 3 ns in step of 1 ps on 2 channel outputs
Option 3:	(Bank of 2 channels) 3 V to 10V channel output, width = 10 ns to 10 ms, rise/fall time = 1/1 ns into 50 Ω
Option 4:	(Bank of 2 channels) 15 V to 50 V channel output, width = 50 ns to 5 μs, rise/fall time = 3/15 ns into 50 Ω
Option 5:	(Bank of 1 channel) with a max of 2 differential LVDS or HSTL outputs, 175 mV to 1200 mV, width = 10 ns to 10 s, rise/fall time <0.5/0.5 ns under 100 Ω differential, and 10 ps channel to channel jitter or 4 ps channel to channel jitter with "option 2" <u>Narrow pulse mode</u> : it allows min width of 1 ns in step of 100 ps with base version, or 500 ps min width in step of 1 ps with option 2 (1 ps delay resolution)
Option 6:	(Bank of 1 channel) with a max of 2 differential LVDS or HSTL clock outputs, independently programmable up to 800 MHz, phase adjustable in steps of 71 ps
Option 7:	Bluetooth
Option 8:	Case with mounting flanges
Option 9:	5" SMB to BNC cable
Option 10:	Jitter improvement (<100 ps rms) between external trigger and outputs, min width reduced to 1 ns

### Ordering information

Model GFT1604-4C	4 channel mini pulse & delay generator (base version)
Model GFT1604-8C	8 channel mini pulse & delay generator (with option 1)



# GFT1604

## Mini Pulse & Delay Generator

### Operating Information

#### Block diagram of the generator

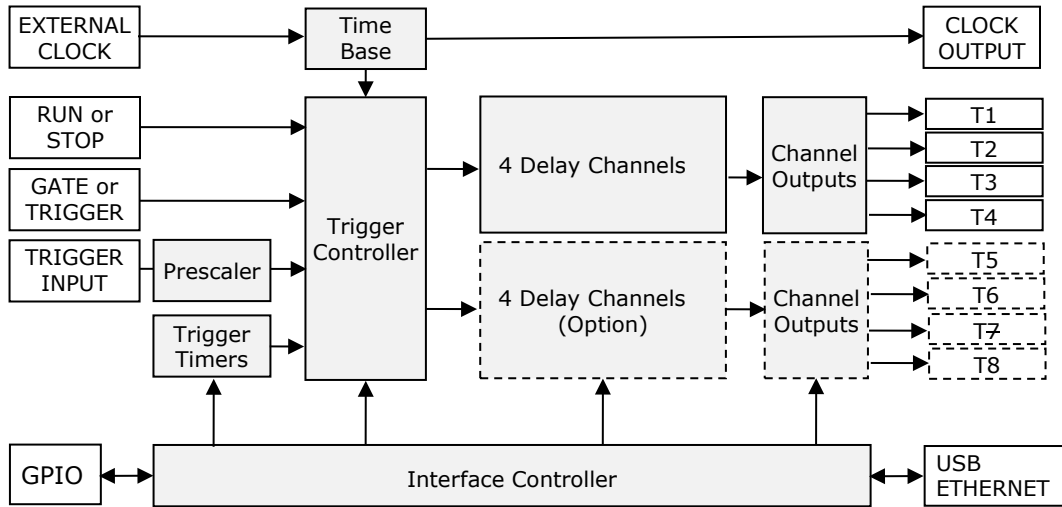

**Time base:** This function provides a 200 MHz time base from an internal reference or an external 10 MHz to 240 MHz reference. The internal time base is available (Clock out) on the rear panel.

**Trigger controller:** This function provides 2 Trigger Modes,

- **External Trigger Mode:** In this mode, a rising edge on input "Trigger input" triggers all delay channel. On every channel trigger rate can be single or repetitive or inhibited.

A prescaler may be used to divide the Trigger Input frequency by integer value from 1 to 1 000 000 000.

- **Internal Trigger Mode:** In this mode delay channels can be triggered from 3 frequency programmable Timers. On every channel trigger rate can be single, synchronized on trigger sources (Trigger input, Timers, Command), or repetitive or burst, or inhibited.

The seven (7) Trigger sources that are possible for each channel are presented in a below chart.

	Trigger sources						
	Trigger input	Gate input	Timer N°1	Timer N°2	Timer N°3	Command	Inhibited
External mode	X	X					
Internal mode			X	X	X	X	X

#### Trigger sources

"Gate Input" allows to quickly inhibit all selected channel outputs. This input function can be selected as a second External Trigger or an input/output for daisy chaining two GFT1604 generators.

Run or Stop button enables or disables the output for any channels.

**Delay Channel:** They are 4 independent delay channels (or 8 in option). The delay from selected trigger source is programmable up to 100 seconds in 100 ps increments (1 ps in option).

#### **Channel Output**

Each delayed output pulse (T1 to T4 or T5 to T8) can be independently adjustable in level (1.5 V to 5 V in 1 mV steps), width (10 ns to 10 s in 5 ns steps), and polarity, and may be ORed' to all other outputs. The outputs are designed to drive 50 Ω load. On "High impedance" load, output level will be twice.

In option every channel output level can be 3 V to 10 V or 15 V to 50 V into 50 Ω or under LVDS or HSTL standard (ask to the factory for mixed channel output level configuration).

Burst mode: On each Channel Output the number of pulses can be adjustable with Burst count and Burst period.

Narrow pulse mode (available with options 2 or 5): this mode uses two delay channels, one to start the output pulse, and the other one to stop the pulse. So, in this mode, the output pulse can be narrower and precisely adjusted in time.

Frequency generator (available with option 6): each differential LVDS or HSTL outputs can generate a programmable clock between 10 kHz and 850 MHz with adjustable phase, or a delayed pulse.

**Interface Controller:** It manages internal functions and user interface. All the parameters can be remote controlled via USB to UART and Ethernet (10/100 Mb/s). A Bluetooth interface is available in option.

All parameters' values are automatically saved and can be stored in 8 different user sets.

"GPIO": Four lines, input, or output, under software command allow to control other devices.

**Stand-alone:** The GFT1604 can be used without PC. PC is only needed to change the pulses characteristics. When the unit is powered-up, an Auto-Run mode allows the unit to start providing output pulses automatically.

### Example of channel outputs mode

#### Mode repetitive and single

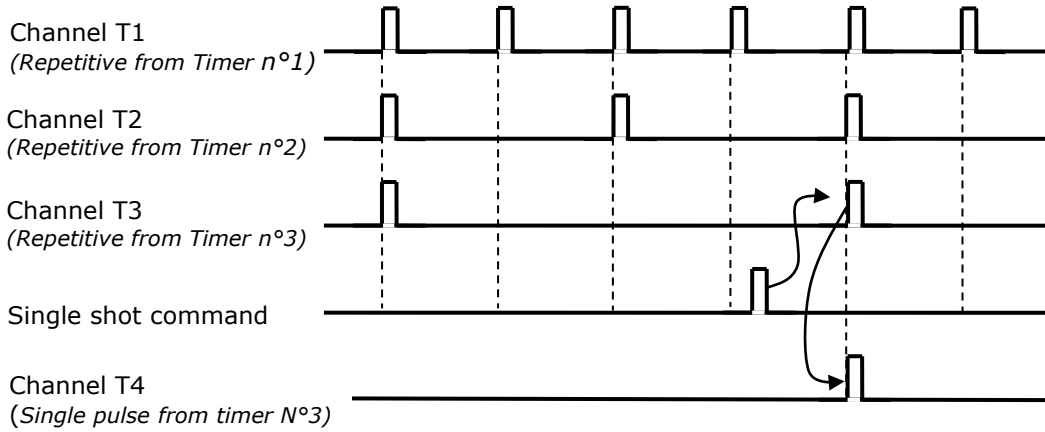

#### Mode burst and Mux

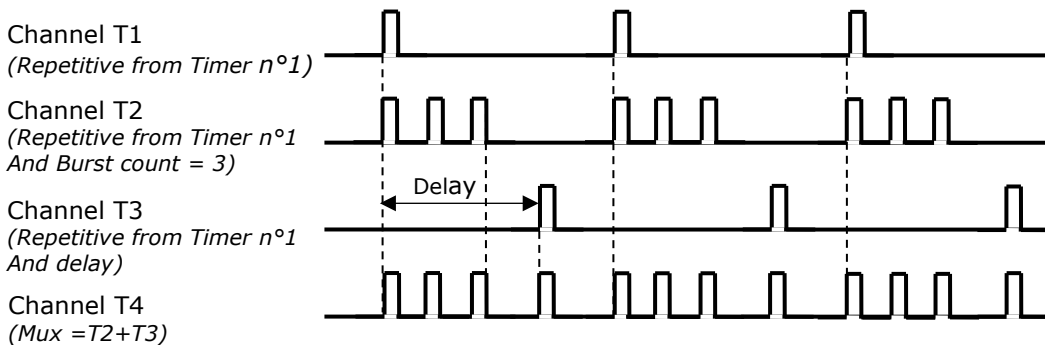

#### Pulse picking (Synchronized on Timer N°3)

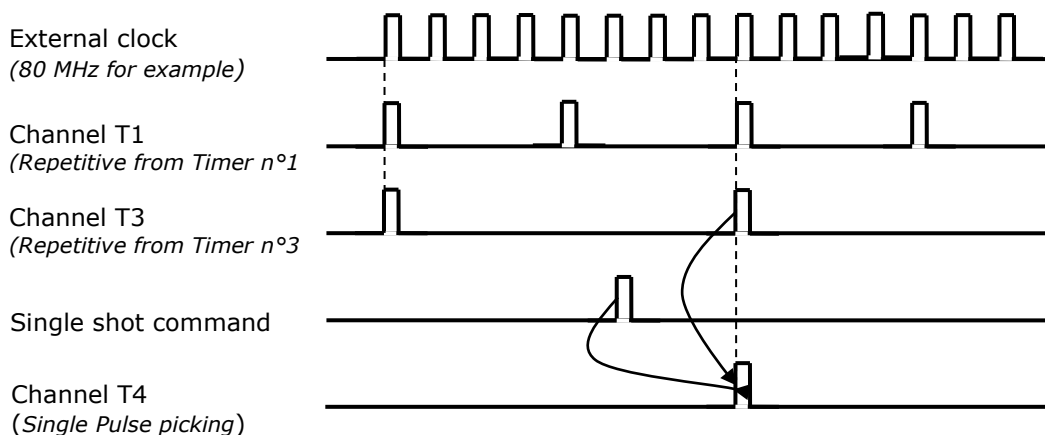

### Example of output pulse

5 V into 50  $\Omega$  base version  
 $R_t = 680$  ps,  $F_t = 740$  ps

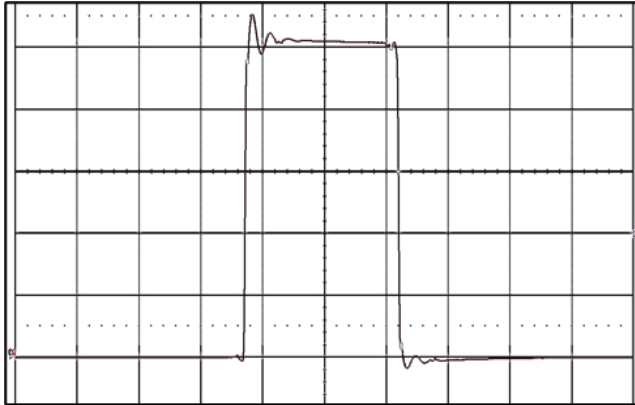

(20 ns/div, 1.0 V/div)

10 V, 10 ns with option 3  
 $R_t = 790$  ps,  $F_t = 770$  ps

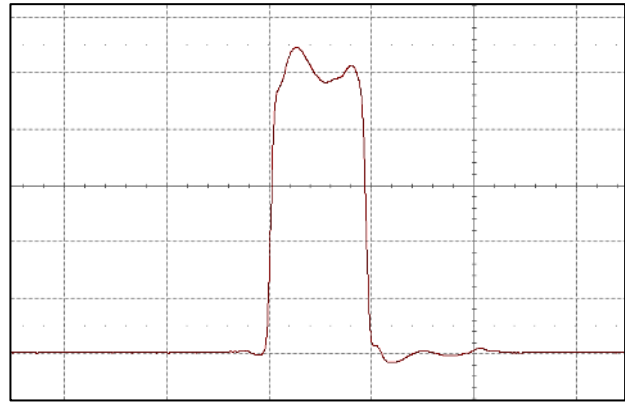

(10 ns/div, 2.0 V/div)

10 V, 10 ms width pulse with option 3  
 $R_t = 800$  ps,  $F_t = 800$  ps

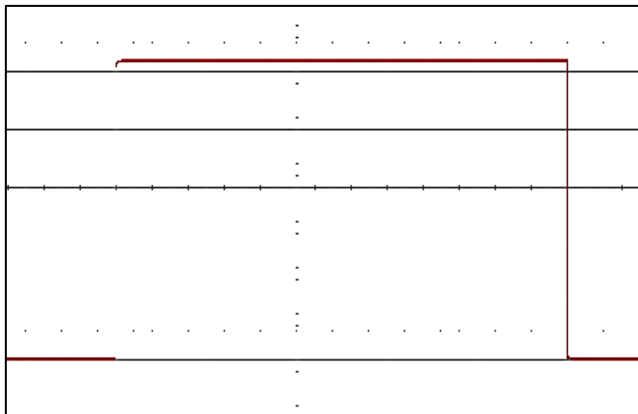

(2 ms/div, 2 V/div)

10 V, 10 ns width in burst mode with option 3  
 Into 50  $\Omega$  at 50 MHz rate

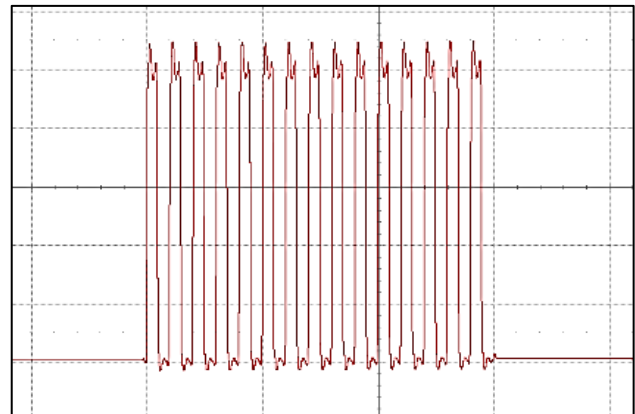

(100 ns/div, 2.0 V/div)

Narrow pulse mode with option 2  
 5 V an 3 to 4 ns multi pulses widths

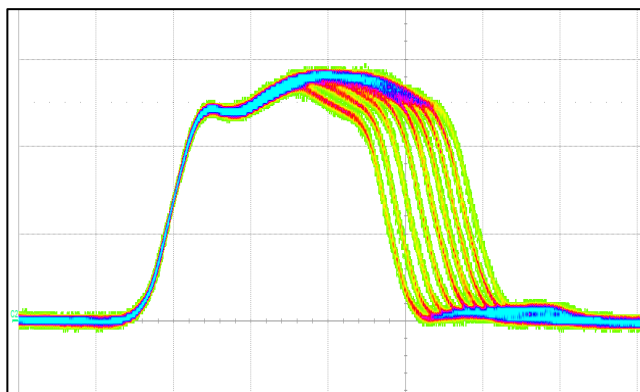

(1 ns/div, 2.0 V/div)

View from scope in infinite persistence

Narrow pulse mode with option 5 (LVDS)  
 1.1 V and 500 to 1500 ps multi-pulse widths

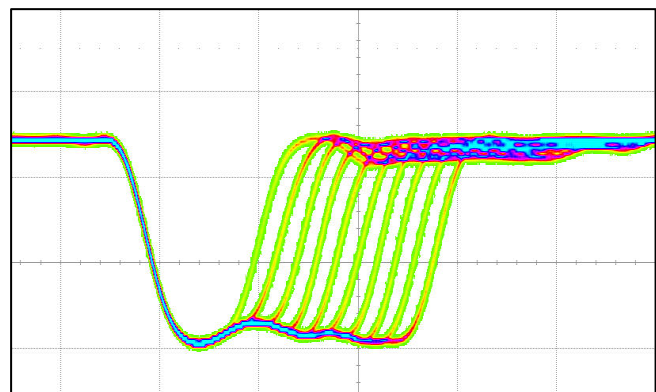

(500 ps/div, 0.5 V/div)

View from scope in infinite persistence





# GFT1604 Mini Pulse & Delay Generator

## Control and software tools

There are two ways to control the generator: Easy remote and General remote.

**Easy remote way** via Ethernet and control panel web pages (without any specific software application). Web page, from embedded Web server, provides easy method to configure settings.

- A Main menu allows to display and control.
  - Trigger and clock system (Trigger level slope, prescaler, clock input/output, trigger generators F1 or F2 or F3)
  - Delay channel (Trigger source, trigger rate, delay, amplitude / width/polarity of channel output pulse)
  - Extended delay channel settings (burst mode, gate and MUX mode)
  - "RUN" button enables the output for all delay channels
  - "Trigger" button may be used to enable a "single trigger" synchronized with the selected trigger source
- A secondary menu selected with "parameter" button allows to change the IP address and configure specific parameters.
- Another secondary menu selected with "GPIO" button allows to configure Input/Output lines
- "Chart View" button opens a window to display in real time every channel output in a common time chart. Zoom & cursor functions make it possible to visualize and control time details (see example below)

The configuration information (all the settings) of the instrument is stored and saved in the GFT1604.

The web page can be opened via Edge, Mozilla Firefox or Chrome.

After connecting a cable from the GFT1604 Ethernet port to your computer network, enter the GFT1604 IP address into your PC's browser (the IP address can be identified in User's manual). The browser will automatically open the control panel web page on your PC.

The screenshot displays the control panel web page for the GFT1604 Mini Pulse & Delay Generator. At the top, it shows the model (GFT1604 4.0.4.0) and serial number (109). The interface is divided into several sections:

- TRIGGER and CLOCK SYSTEM:** Includes input settings for Ext1 and Ext2 (Trigger, Prescaler, Level, Edge), external clock options (No/On), and generator frequencies (F1: 1,000,000 Hz, F2: 50,000 Hz, F3: 1,000 Hz). A large green "RUN" button and a "Trigger" button are present.
- DELAY CHANNEL:** A table with columns for Trigger Source, Trigger Rate, Delay (ps), Width (ns), Amplitude (mV), and Polarity. It lists four channels (T1-T4) with their respective settings.
- EXTENDED SETUP:** Shows status indicators for Temperature (40.5 °C), Current (628 mA), CLKIN Frequency (0 Hz), and Lock/External Power/Fault/Overload status. Buttons for Save/Recall, Settings, GPIO, and Info are also visible.
- Chart View:** A real-time waveform display showing the outputs of T1, T2, T3, and T4 over a 20,000 ns period. A blue arrow points from the "Chart View" button in the DELAY CHANNEL section to this window.

*Control panel web page with Real Time Chart View under*

**General remote way** via Ethernet or USB and software application (see examples in the User's manual). A USB application with GUI similar as web page control panel web page is furnished.

# GFT1604

## Mini Pulse & Delay Generator

### Front and rear panel

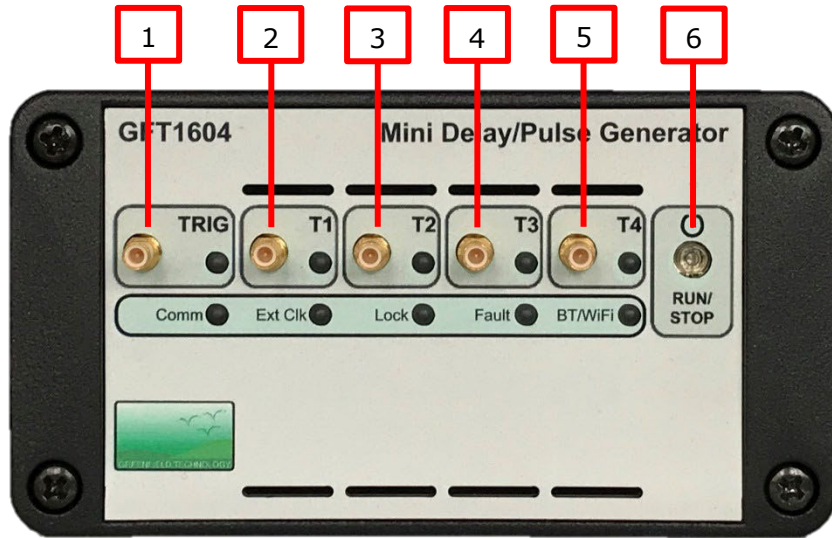

*Front panel*

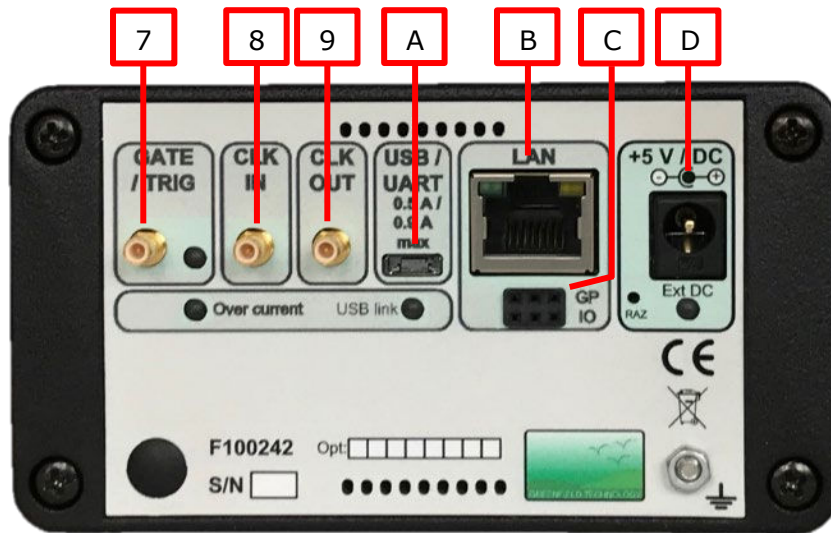

*Rear panel*

### Connectors, switch

Front panel		Rear panel	
	• Connector		• Connector
1	Trigger input: SMB connector	7	Gate input: SMB connector
2	T1 channel output: SMB connector	8	Clock input: SMB connector
3	T2 channel output: SMB connector	9	Clock output: SMB connector
4	T3 channel output: SMB connector	A	USB connection: micro-AB connector
5	T4 channel output: SMB connector	B	LAN connection: RJ45 connector
	• Switch	C	GPIO: SHM-103 Samtec connector
6	Power ON/OFF or RUN/STOP channel outputs	D	+5V DC power plug: Jack 2.10 mm

### Pulse shaping modules

Model	Description
GFT101	1 ns rise time, Electrical to optical Pulse Converter
GFT200	Optical to electrical converter: combined with GFT101 it allows to transmit fast pulse up to 1 Km
GFT300	Sub nanosecond Pulse Stretcher from pick up diode to provide GFT1604 clock reference
GFT614	1 to 4 line 50 Ω Driver, up to 150 MHz rate
GFT632	15 - 70 V, <2 ns rise time under into 50 Ω, Pulse Generator
GFT644	4 channel, 50 Ω TTL line Driver, up to 150 MHz rate